

### Dolby\* B Type Noise Reduction System

#### Description

CXA1100, CXA1101, CXA1102 and CXA1163 are ICs including two separate Dolby B type noise reduction processors. Seven devices with four Dolby levels and two types of package are provided for various applications. These devices feature very few external components, which is achieved by integrated filter circuits using integrated thin film capacitors with high capacitance.

16 pin DIP (Plastic)

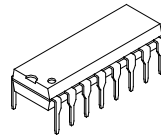

16 pin SOP (Plastic)

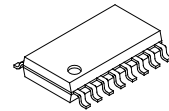

#### Features

- Minimum number of external components
- NR ON/OFF and REC/PB switches included
- Small package (DIP16, SOP16)
- Small supply current ( $\approx 5.5\text{mA}$ , Typ.)
- Dual channel processors in one chip

#### Absolute Maximum Ratings (Ta = 25°C)

- Supply voltage  $V_{CC}$  17 V
- Operating temperature  $T_{opr}$  -30 to +85 °C
- Storage temperature  $T_{stg}$  -55 to +150 °C
- Allowable power dissipation  $P_D$ 
  - DIP16 (A1100P/A1101P/A1102P/A1163P) 900 mW
  - SOP16 (A1101M/A1102M/A1163M) 500 mW

**Note 1)** These ICs are available only to the licensees of Dolby Laboratories Licensing Corporation from whom licensing and application information may be obtained.

**Note 2)** "Dolby" and double D symbols are trademarks of Dolby Laboratories Licensing Corporation.

Pin Description

(Ta = 25°C, Vcc = 12V (Single supply), No signal)

No.	Symbol	Z (in)	VDC	Equivalent Circuit	Description
1, 16	REC IN	40kΩ	6.0V		Recording (Encode) input
2	Vcc	—	12.0V		Power supply
3, 14	PB IN	40kΩ	6.0V		Playback (Decode) input
4	Vcc/2	1kΩ	6.0V		Single supply → Vcc/2 Split supply → Ground
5	ON/OFF	—	—		Mode control pin for NR ON/OFF "H" → NR OFF "L" → NR ON
6, 11	LINE OUT	—	6.0V		Line (Decode) output

No.	Symbol	Z (in)	VDC	Equivalent Circuit	Description
7, 10	TC	—	0.3V		Time constant pin for the level detector
8, 9	REC OUT	—	6.0V		Recording (Encode) output
12	REC/PB	—	—		Mode control pin for REC/PB (Encode/Decode) "H" → B (Decode) "L" → EC (Encode)
13	IREF	—	1.2V		Reference current input pin for the active filters
15	GND	—	0V		Single supply → Ground Split supply → V <sub>EE</sub>

Block Diagram

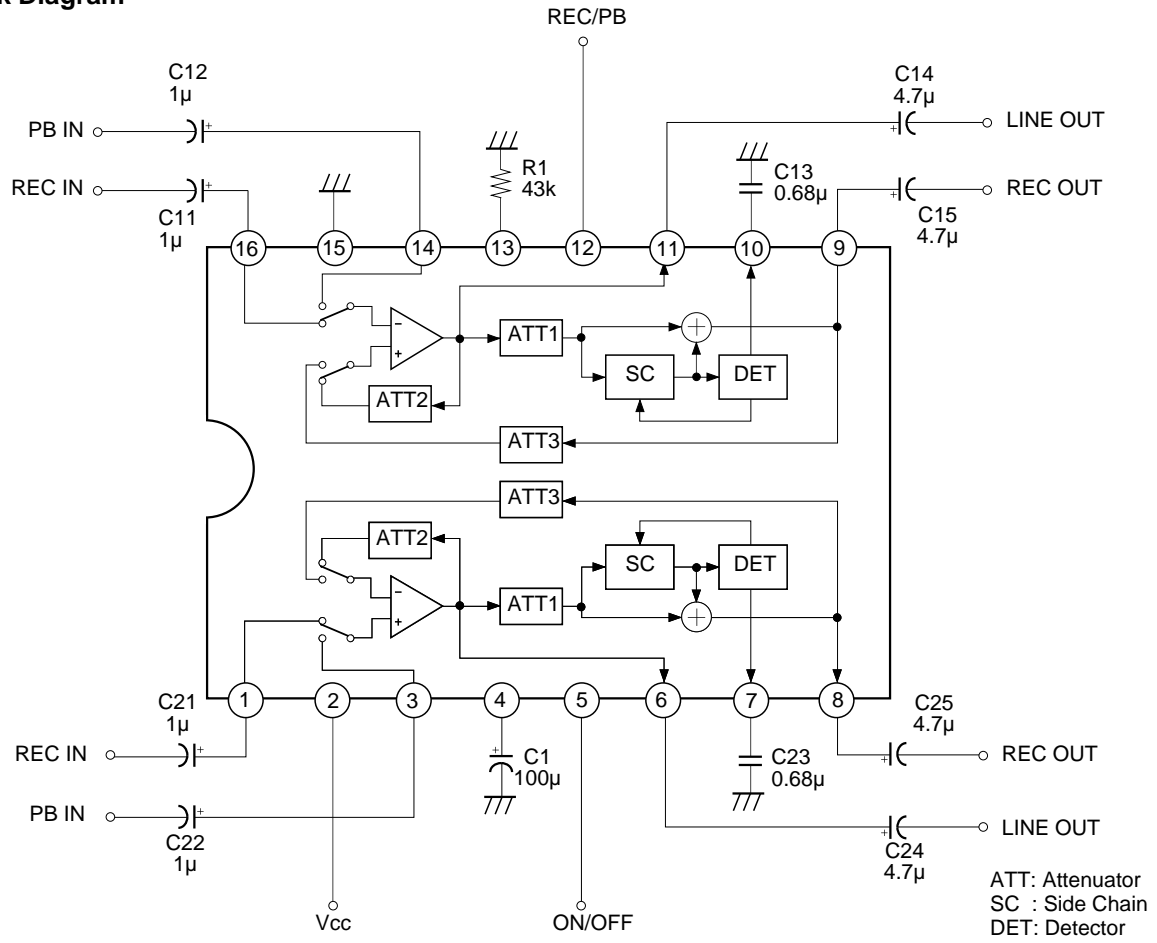

Test Circuit

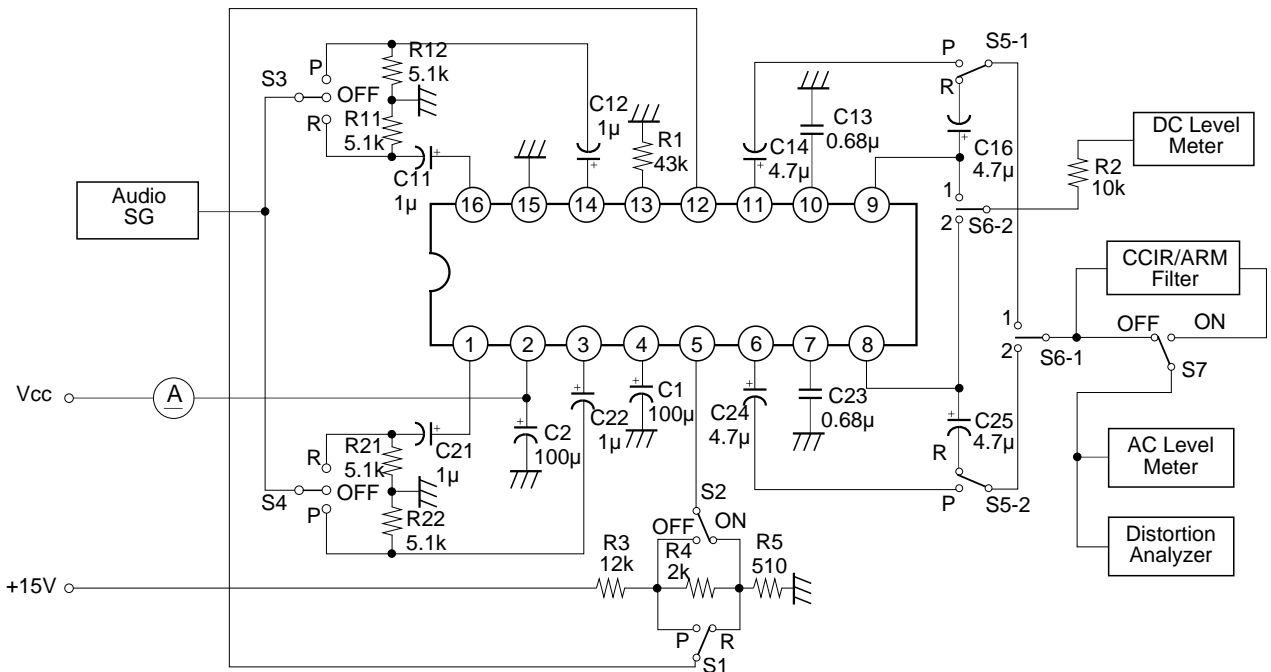

**Electrical Characteristics**

Ta = 25°C, Dolby Level: -10dBm (= 245mVrms) at REC OUT  
 Vcc = 15V (CXA1100), Vcc = 12V (CXA1101), Vcc = 9V (CXA1102)  
 Vcc = 6V (CXA1163)

Item	Symbol	Test Condition*				Min.	Typ.	Max.	Unit
		R/P	NR	f (Hz)	Other Conditions				
Operating voltage CXA1100 CXA1101 CXA1102 CXA1163	Vopr	—	—	—	Signal Handling ≥ 12dB	11.5 8.5 6.5 5.0	— — — —	16.0 16.0 16.0 16.0	V V V V
Supply current CXA1100 CXA1101 CXA1102 CXA1163	Icc	R	OFF	—	No signal	3.5 3.5 3.5 3.5	5.6 5.5 5.3 5.1	7.5 7.5 7.5 7.5	mA mA mA mA
LINE OUT level CXA1100 CXA1101 CXA1102 CXA1163	Vlout	R	OFF	1k		-1.0 -4.0 -7.0 -11.0	0.0 -3.0 -6.0 -10.0	1.0 -2.0 -5.0 -9.0	dBm dBm dBm dBm
REC IN level	Vrin	R	OFF	1k		-32	-30	-28	dBm
PB IN level	Vpin	P	OFF	1k		-32	-30	-28	dBm
Encode characteristics (Boost)									
(1)	B-R-1	R	ON	500	-25dB	1.4	2.9	4.4	dB
(2)	B-R-2	R	ON	2k	-25dB	5.5	7.0	8.5	dB
(3)	B-R-3	R	ON	5k	-25dB	3.9	5.4	6.9	dB
(4)	B-R-4	R	ON	10k	-40dB	9.7	10.4	11.9	dB
(5)	B-R-5	R	ON	10k	0dB	-1.1	0.4	1.9	dB
Signal handling CXA1100 CXA1101 CXA1102 CXA1163	Vomax	R	OFF	1k	THD = 1%	13.5 14.0 14.0 13.0	15.3 15.9 15.9 15.0	— — — —	dB dB dB dB

0dBm = 0.775Vrms

Item	Symbol	Test Condition*				Min.	Typ.	Max.	Unit
		R/P	NR	f (Hz)	Other Conditions				
Total harmonic distortion									
1) NR OFF	THD (OFF)	R	OFF	1k	+10dB	—	0.03	0.2	%
CXA1100						—	0.04	0.2	%
CXA1102						—	0.05	0.2	%
CXA1163						—	0.06	0.2	%
2) NR ON	THD (ON)	R	ON	1k	+10dB	—	0.03	0.3	%
CXA1100						—	0.04	0.3	%
CXA1102						—	0.06	0.3	%
CXA1163						—	0.09	0.3	%
Input impedance									
REC IN	Zrec	—	—	1k		28	40	57	kΩ
PB IN	Zpb	—	—	1k		28	40	57	kΩ
Encode S/N ratio	SN (CCIR)	R	ON	—	Rg = 5kΩ (CCIR/ARM)	65	69	—	dB
Crosstalk									
REC-PB	CT-1	P	OFF	1k	0dB	—	-82	-65	dB
PB-REC	CT-2	R	OFF	1k	0dB	—	-81	-60	dB
REC ch to ch	CT-3	R	OFF	1k	0dB	—	-70	-60	dB
PB ch to ch	CT-4	P	OFF	1k	0dB	—	-70	-60	dB
REC OUT									
Offset voltage (NR ON — OFF)	Voff	R	ON	—		-40	0	40	mV
Control voltage									
"H" Level	VC-H	—	—	—		2.5	—	Vcc	V
"L" Level	VC-L	—	—	—		0	—	0.5	V

\* 0dB means the level which provides the Dolby level at the recording output in the noise reduction off mode.

Example of Representative Characteristics

Quiescent Current vs. Supply Voltage

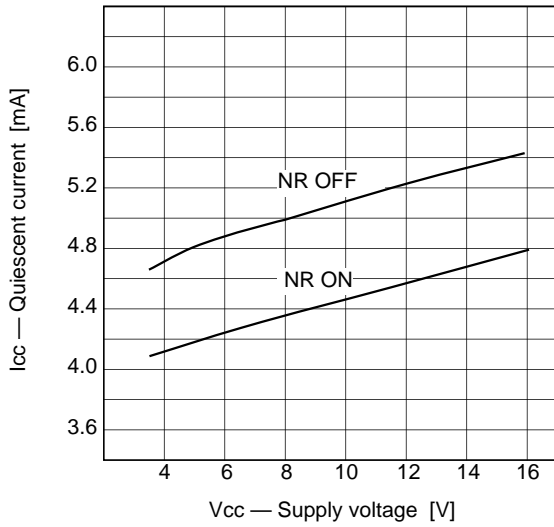

Supply Current vs. Input Voltage (CXA1101)

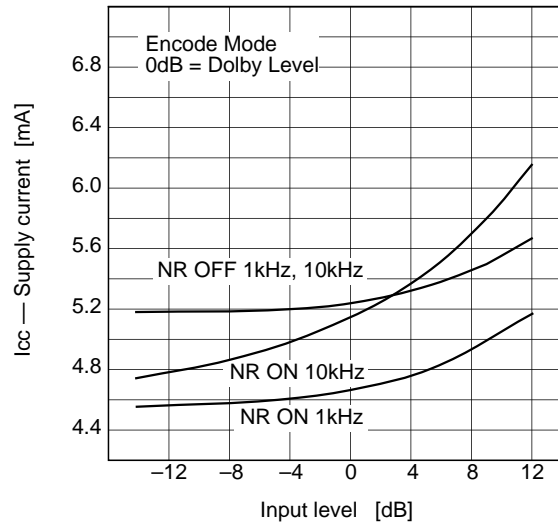

Encode Characteristics

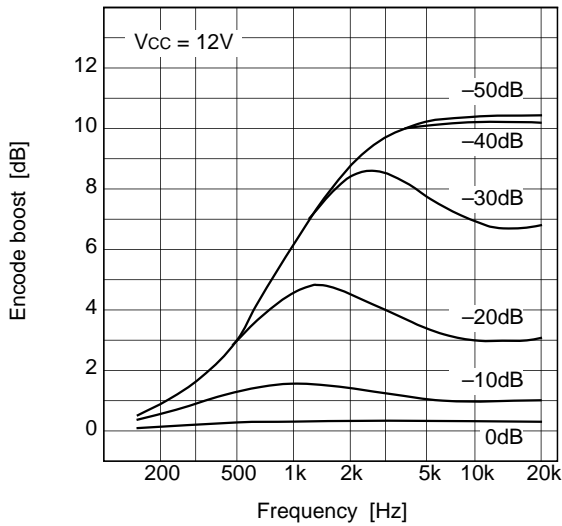

Temperature Characteristics

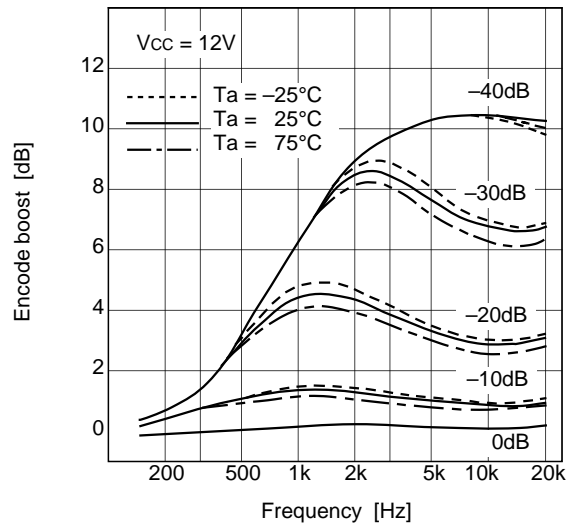

Signal Handling

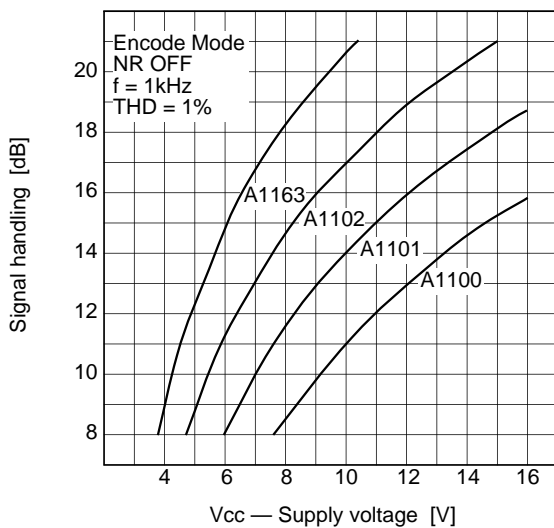

Load Characteristics (CXA1101)

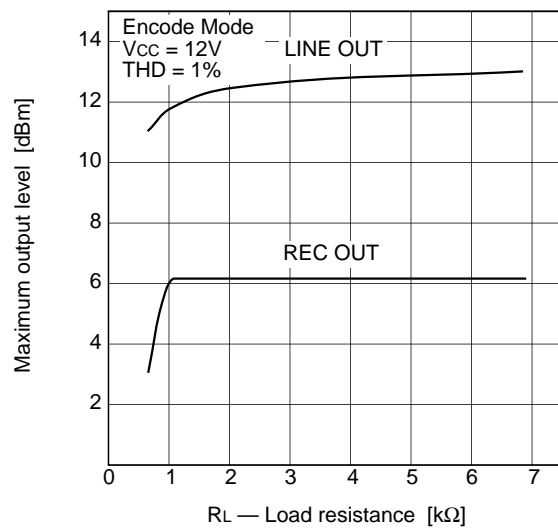

**NR off Total Harmonic Distortion-1 (CXA1101)**

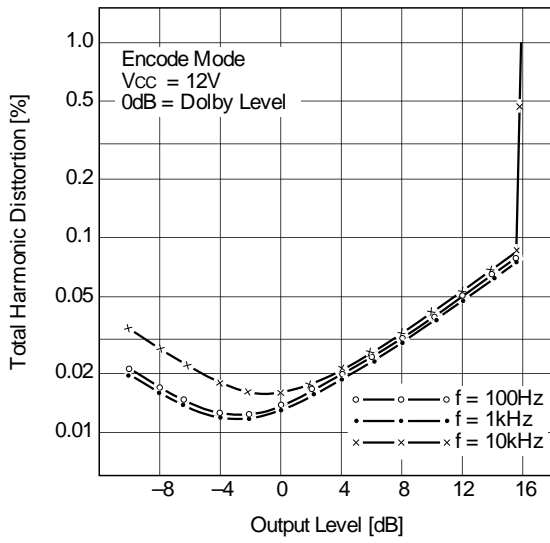

**NR on Total Harmonic Distortion-1 (CXA1101)**

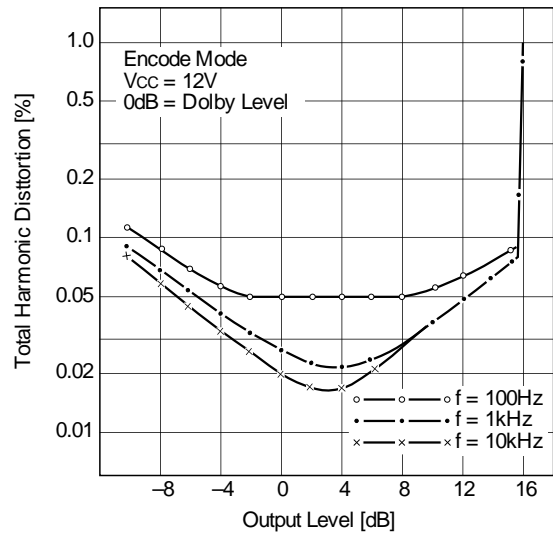

**NR off Total Harmonic Distortion-2 (CXA1100)**

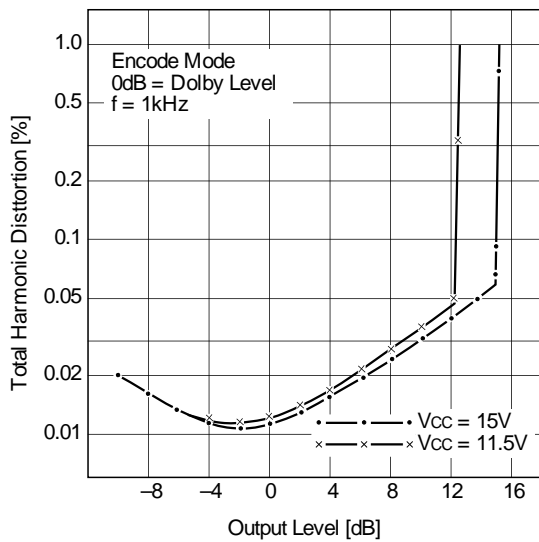

**NR on Total Harmonic Distortion-2 (CXA1100)**

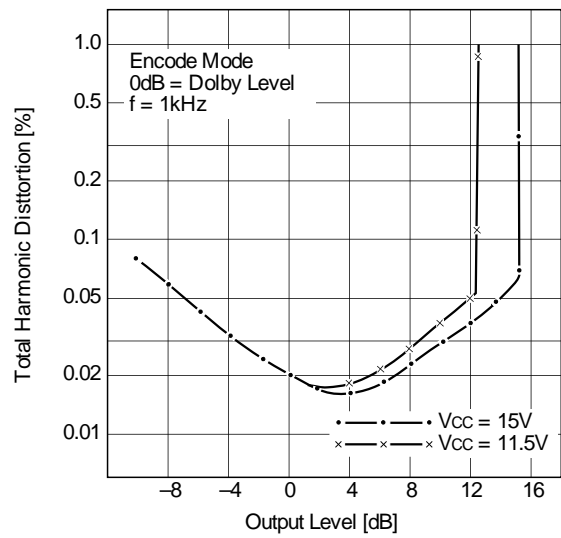

**NR off Total Harmonic Distortion-3 (CXA1101)**

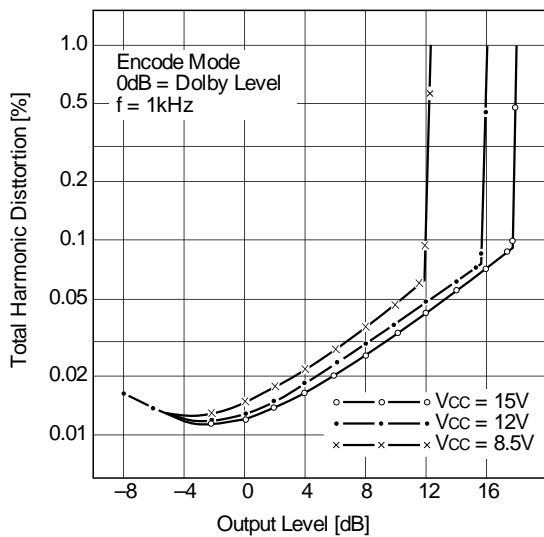

**NR on Total Harmonic Distortion-3 (CXA1101)**

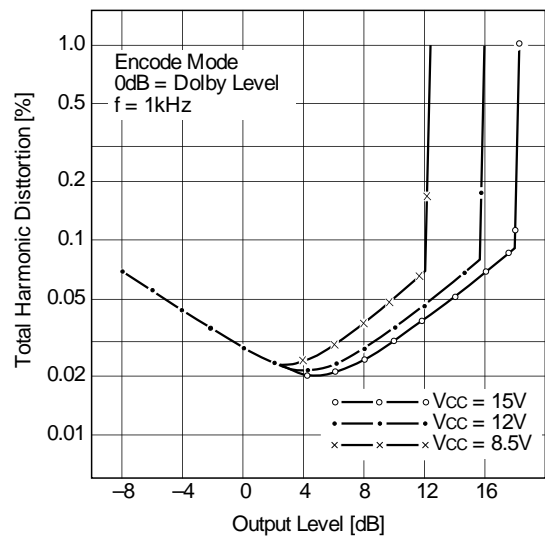



**NR off Total Harmonic Distortion-4 (CXA1102)**

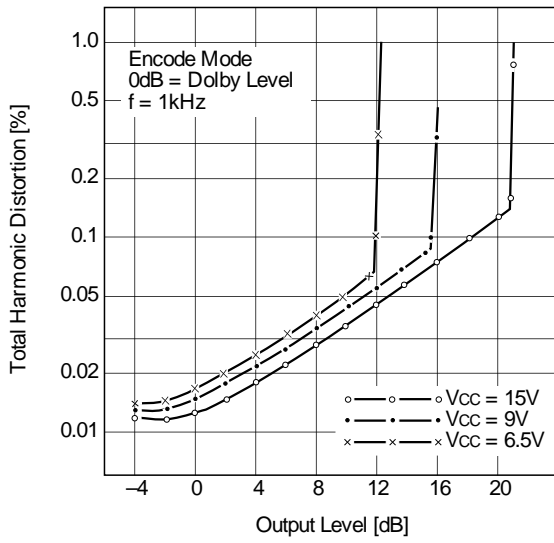

**NR on Total Harmonic Distortion-4 (CXA1102)**

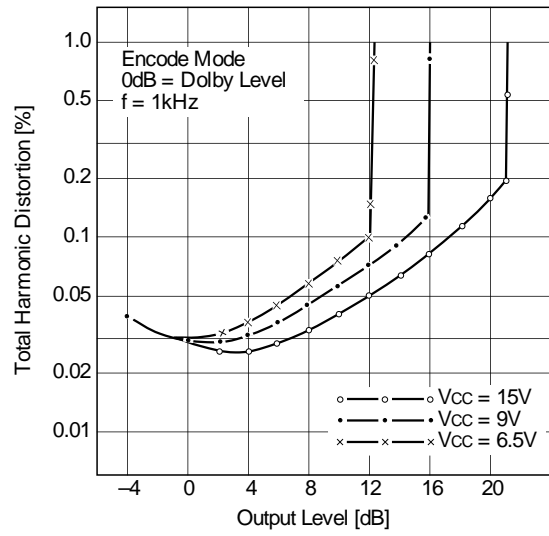

**NR off Total Harmonic Distortion-5 (CXA1163)**

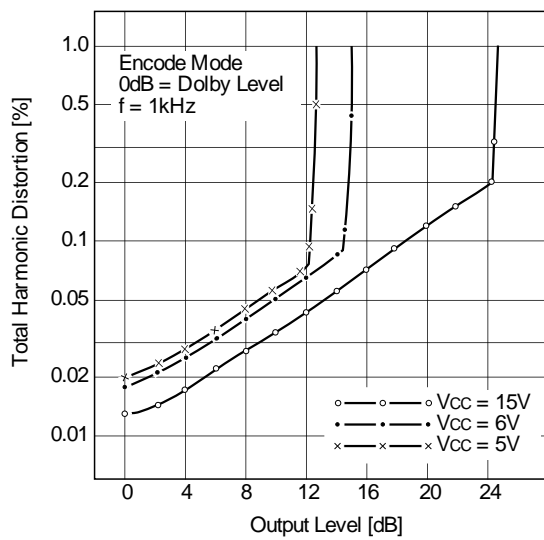

**NR on Total Harmonic Distortion-5 (CXA1163)**

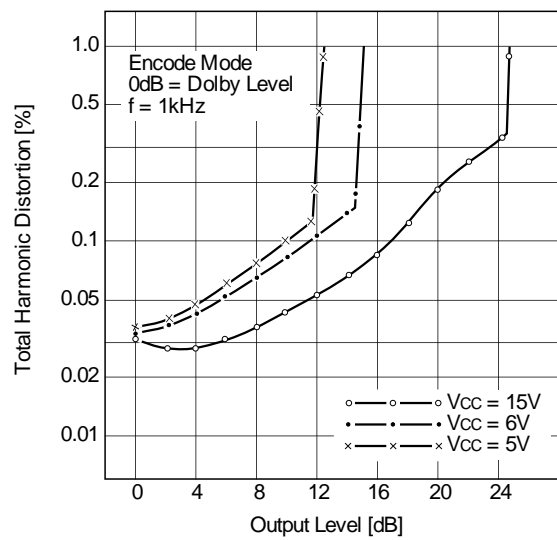

**Channel to Channel Crosstalk (CXA1101)**

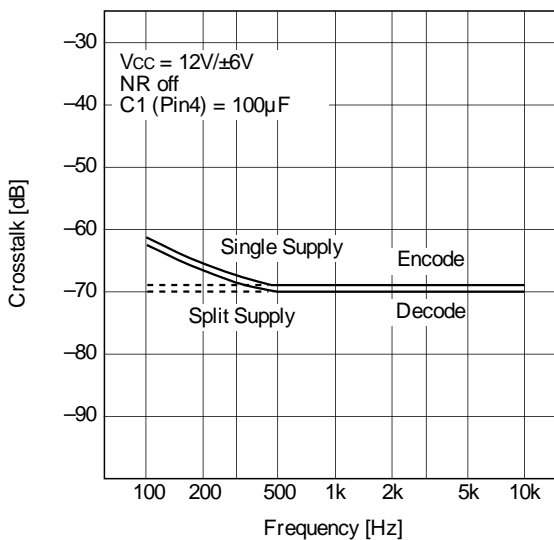

**REC to PB and PB to REC Crosstalk (CXA1101)**

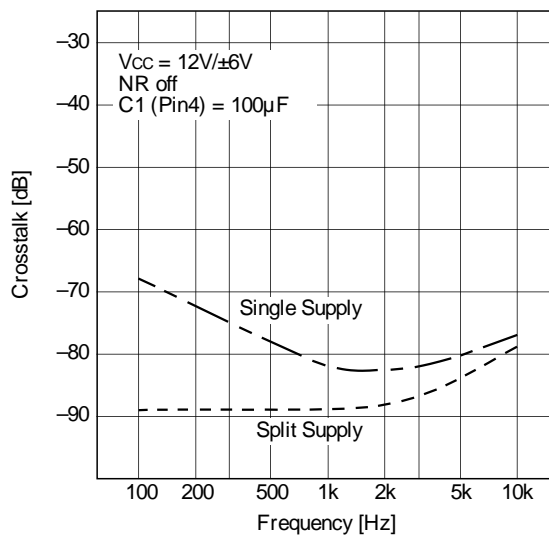

**Ripple Rejection Ratio-1  
(CXA1101)**

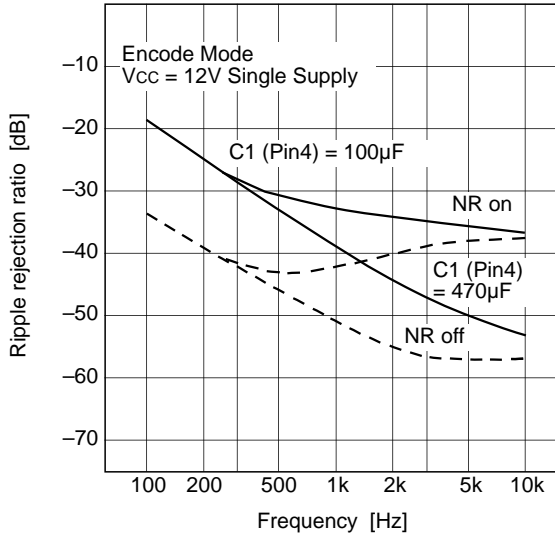

**Ripple Rejection Ratio-2  
(CXA1101)**

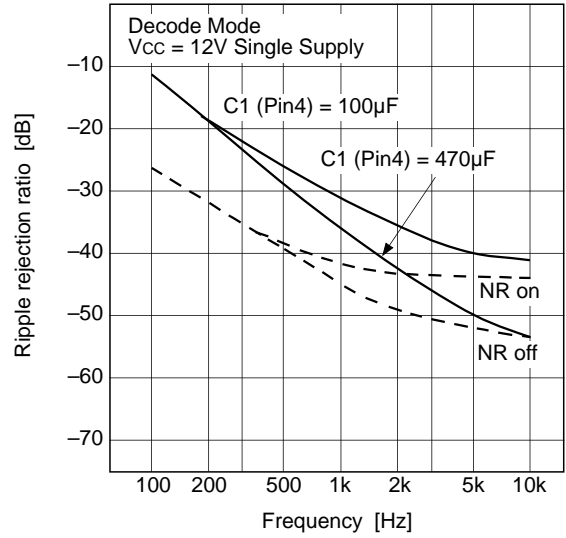

**Ripple Rejection Ratio-3  
(CXA1101)**

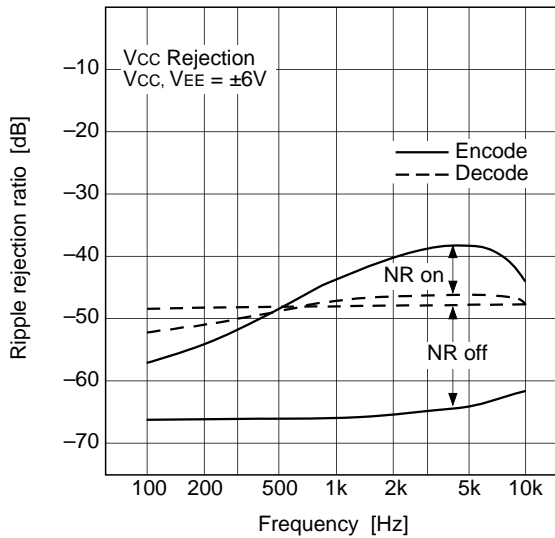

**Ripple Rejection Ratio-4  
(CXA1101)**

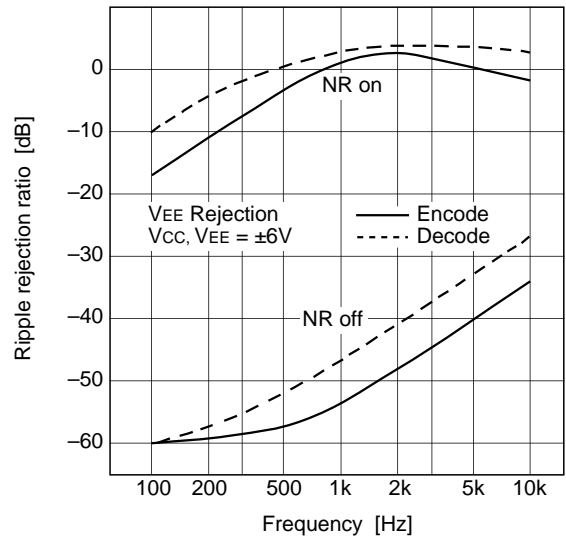

**Notes on Applications**

1) Power supply

The CXA1100 Series is basically designed to operate on single ended supply. The split supply operation is also possible, however,  $V_{EE}$  (negative) supply should provide low noise and ripple characteristics. The ripple rejection ratio of these devices is generally good for  $V_{cc}$  supply (single ended supply and split supply), however, that for  $V_{EE}$  supply is not so good in the NR on mode because the integrated capacitors for the side chain filter are connected to pin 15 ( $V_{EE}$  on split supply).

When the ripple or noise component of  $V_{EE}$  supply is not negligible small, the CR filter shown in Fig. a-1 will be usefull.

The operation voltage range are

CXA1100	11.5 to 16V ( $\pm 5.75$ to $\pm 8V$ )
CXA1101	8.5 to 16V ( $\pm 4.25$ to $\pm 8V$ )
CXA1102	6.5 to 16V ( $\pm 3.25$ to $\pm 8V$ )
CXA1163	5.0 to 16V ( $\pm 2.5$ to $\pm 8V$ )

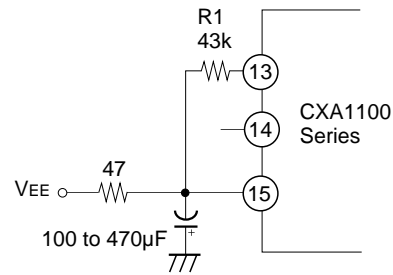

Fig. a-1.

The devices will satisfy the signal handling of 12dB specified by Dolby Laboratories on above voltage range.

2) Operation mode control

The CXA1100 series provide fully electronic switching circuits. The functions are controlled by DC voltages of the two control pins of REC/PB (pin 12) and ON/OFF (pin 5). The switching truth tables are shown in Fig. a-2.

$V_H$  and  $V_L$  are defined as

(a) Single ended supply operation

$$V_{CC} \geq V_H \geq 2.5V$$

$$0.5V \geq V_L \geq 0V$$

(b) Split supply operation

$$V_{CC} \geq V_H \geq V_{EE} + 2.5V$$

$$V_{EE} + 0.5V \geq V_L \geq V_{EE}$$

REC/PB	$V_H$	$V_L$
Function	PB (Decode)	REC (Encode)

ON/OFF	$V_H$	$V_L$
Function	NR off	NR on

Fig. a-2.

It is desirable to provide CR time constant circuits at the mode control pins with time constant from 100msec to 1sec, which will reduce switching clicks effectively.

3) Reference levels

Characteristics and specifications of the Dolby noise reduction processor are defined as the levels and measured with reference to the Dolby level. This particular level in these devices is  $-10dBm$  (245mVrms), and is measured at the recording output (REC OUT) in the NR off mode.

The reference levels of the recording input (REC IN), play back input (PB IN) and line output (LINE OUT) are defined the levels which provide the Dolby level at the recording output in the NR off mode.

The CXA1100 series has a common silicon die, and has different internal connection. The series provides four different line output levels for various applications. Other reference levels, recording input level, playback input level and recording output level (= Dolby level) are identical in all devices.

The reference levels are as follows

Recording output level (= Dolby level)		$-10dBm$ (245mVrms)
Recording input level		$-30dBm$ (24.5mVrms)
Play back input level		$-30dBm$ (24.5mVrms)
Line output level	CXA1100	0dBm (775mVrms)
	CXA1101	$-3dBm$ (548mVrms)
	CXA1102	$-6dBm$ (388mVrms)
	CXA1163	$-10dBm$ (245mVrms)

4) MPX filter termination and C<sub>1</sub> for V<sub>cc</sub>/2 (Pin 4)

The MPX (multiplex) filter termination method shown in Fig. a-3 allows saving the coupling capacitors between the buffer amplifiers and MPX filters. However, the channel to channel separation and REC to PB crosstalk of low frequency signals will be degraded by the termination resistor R<sub>T</sub>. For example, 5kΩ of R<sub>1</sub> will degrade the channel to channel separation to 50dB. Better separation can be obtained by increasing the capacitance of C<sub>1</sub> (Pin 4) to 220μF or 470μF.

The allowable minimum value of C<sub>1</sub> is 47μF, and 100μF is the standard recommended value. Larger values of C<sub>1</sub> are generally desirable in order to improve the crosstalk and ripple rejection ratio.

5) Application for dubbing cassette decks

The CXA1100 series generates non decoded signal at the recoding output in the decode mode, and can simplify the structure of dubbing decks. See the SONY' Dolby B/C type IC (CX20187/CXA1097Q or CX20188/CXA1098Q) data sheet in detail.

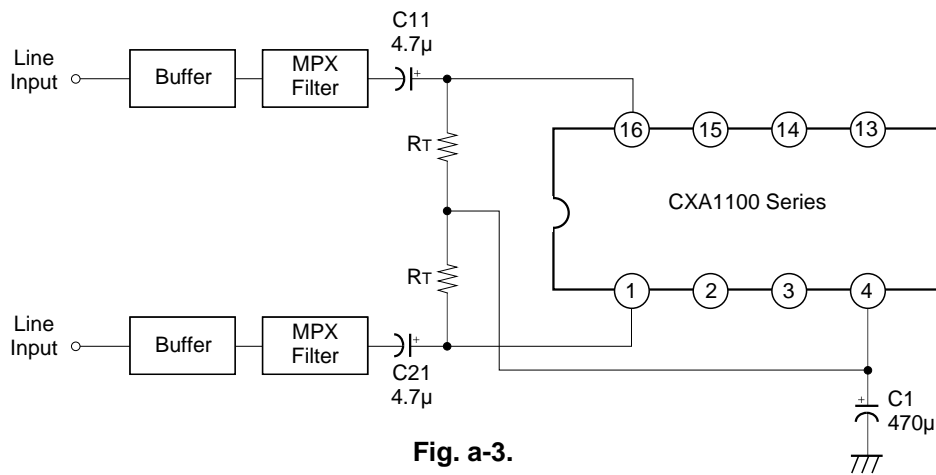
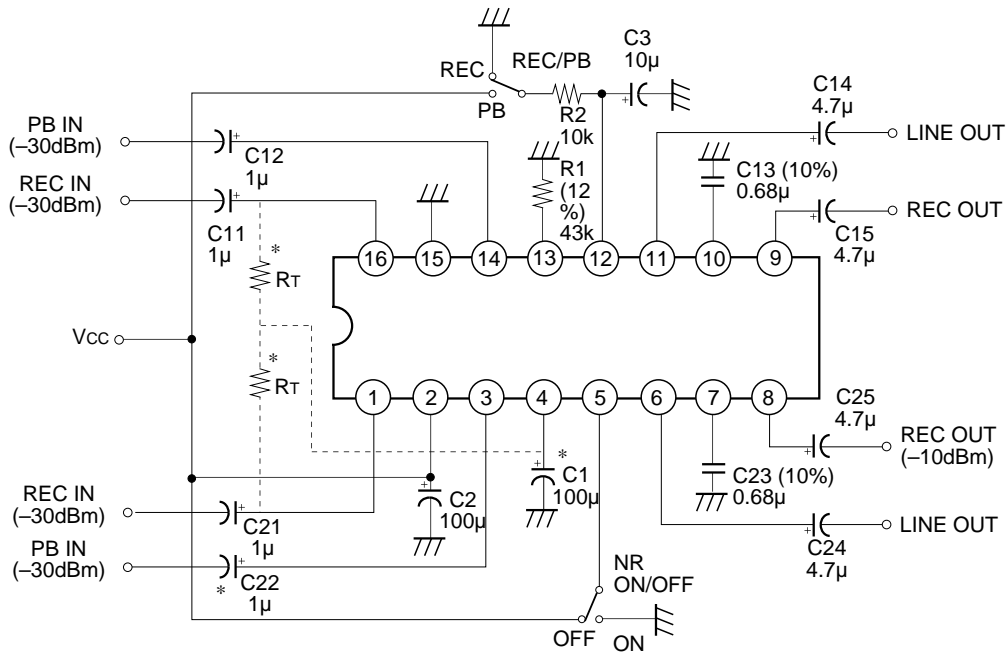

Fig. a-3.

Switchable Processor with Single Supply



**Note 1)** Resistor and capacitor tolerances are ±10% and ±20% respectively unless otherwise specified.

**Note 2)** When resistors R<sub>T</sub> are connected to Pin 4 for the MPX filter termination, increase the capacitances of C<sub>1</sub> and C<sub>11</sub> (C<sub>21</sub>) to 470μF and 4.7μF respectively.

Switchable Processor with Split Supply

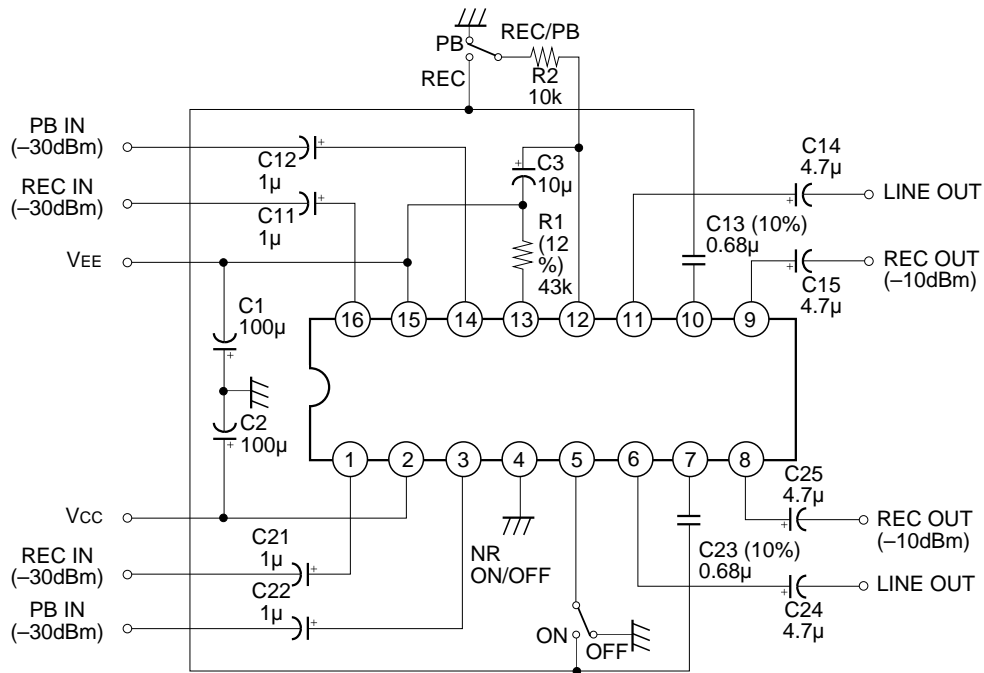

Note 1) Resistor and capacitor tolerances are  $\pm 10\%$  and  $\pm 20\%$  respectively unless otherwise specified.

Playback Processor with AUX input

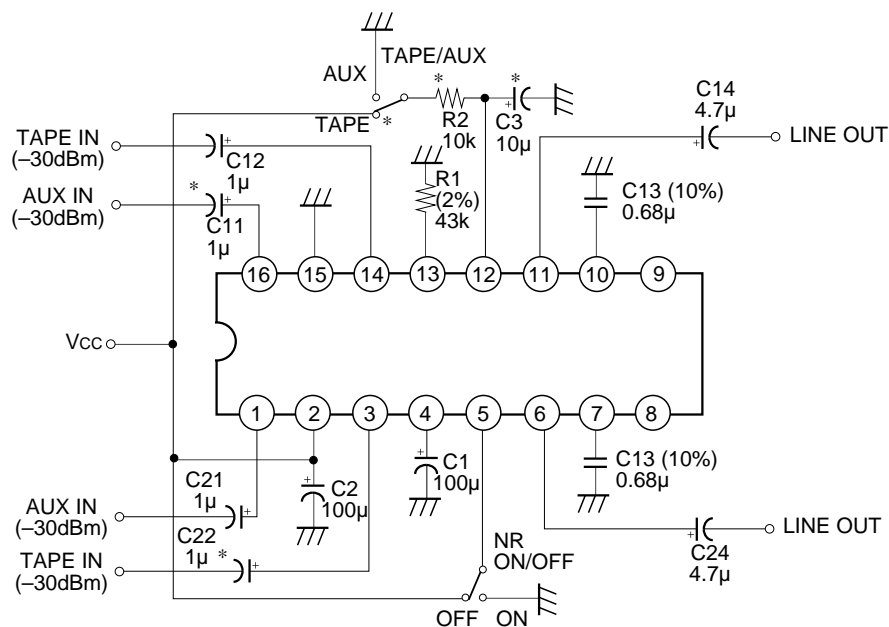

Note 1) Resistor and capacitor tolerances are  $\pm 10\%$  and  $\pm 20\%$  respectively unless otherwise specified.

Note 2) When AUX inputs are not necessary, reject R<sub>2</sub>, C<sub>3</sub>, C<sub>11</sub>, C<sub>21</sub> and TAPE/AUX switch, and connect Pin 12 to Vcc.

Package Outline Unit: mm

CXA1101P, CXA1101P  
CXA1102P, CXA1163P

16PIN DIP (PLASTIC) 300mil

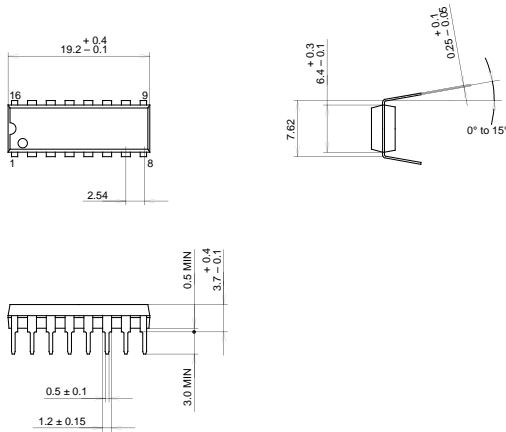

PACKAGE STRUCTURE

PACKAGE MATERIAL	EPOXY RESIN
LEAD TREATMENT	SOLDER PLATING
LEAD MATERIAL	COPPER
PACKAGE WEIGHT	1.0 g

SONY CODE	DIP-16P-01
EIAJ CODE	+DIP016-P-0300-A
JEDEC CODE	Similar to MO-001-AE

16PIN DIP (PLASTIC) 300mil

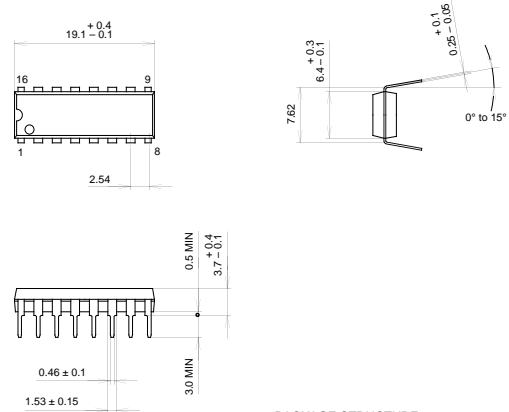

PACKAGE STRUCTURE

PACKAGE MATERIAL	EPOXY RESIN
LEAD TREATMENT	SOLDER PLATING
LEAD MATERIAL	COPPER / 42 ALLOY
PACKAGE WEIGHT	1.0g

SONY CODE	DIP-16P-03
EIAJ CODE	+DIP016-P-0300-B
JEDEC CODE	Similar to MO-001-AE

CXA1101M, CXA1102M  
CXA1163M

16PIN SOP (PLASTIC) 300mil

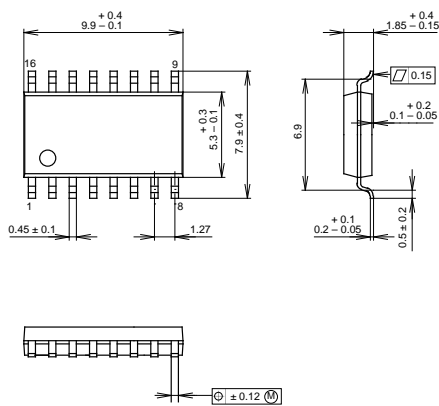

PACKAGE STRUCTURE

PACKAGE MATERIAL	EPOXY RESIN
LEAD TREATMENT	SOLDER PLATING
LEAD MATERIAL	COPPER ALLOY
PACKAGE WEIGHT	0.2g

SONY CODE	SOP-16P-L01
EIAJ CODE	+SOP016-P-0300-A
JEDEC CODE	

CXA1100P, CXA1101P  
CXA1102P

16PIN DIP (PLASTIC) 300mil

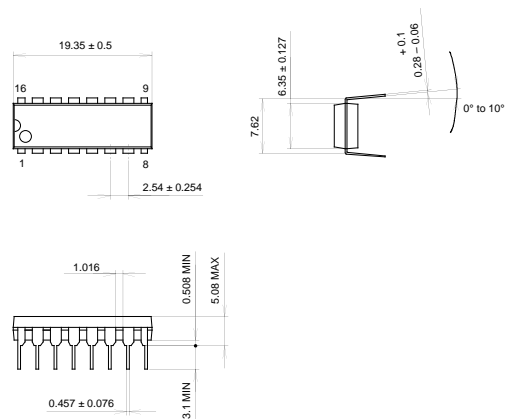

PACKAGE STRUCTURE

PACKAGE MATERIAL	EPOXY RESIN
LEAD TREATMENT	SOLDER PLATING
LEAD MATERIAL	COPPER
PACKAGE WEIGHT	1.0g

SONY CODE	DIP-16P-191
EIAJ CODE	DIP016-P-0300-AU
JEDEC CODE	MS-001-AA

CXA1100P, CXA1101P/M, CXA1102P/M, CXA1163P/M

16PIN SOP (PLASTIC) 300mil

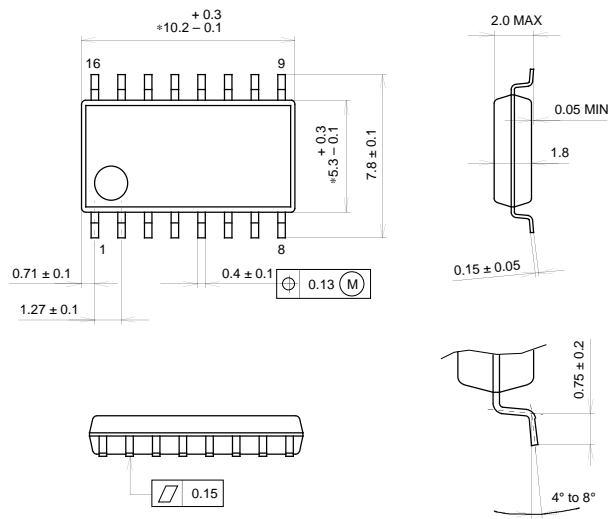

NOTE: Dimension "\*" does not include mold protrusion.

PACKAGE STRUCTURE

SONY CODE	SOP-16P-L122
EIAJ CODE	SOP016-P-0300-BX
JEDEC CODE	_____

PACKAGE MATERIAL	EPOXY RESIN
LEAD TREATMENT	SOLDER PLATING
LEAD MATERIAL	COPPER
PACKAGE WEIGHT	0.21g